

# **BIANCO** iCON CHEAT SHEET

## SERIES CONTROLS



An iCON Series Control is an intelligent, easy to use management system for various pump situations.

Used when you need to control the pump or pumps in different applications.

It can give you real time information on the performance of the pumps.

It will show you the last 5 error codes (if any) for each of the pumps.

**IT PROTECTS THE PUMP.**

### FEATURES & BENEFITS

- IP54 engineered plastic enclosure - complete protection against contact with live or moving parts inside the enclosure. Protection against harmful deposits of dust. The ingress of dust is not totally prevented, but cannot enter in an amount sufficient to interfere with satisfactory operation of the machine. Water splashed against the enclosure from any direction shall have no harmful effect.
- Intelligent real time LCD displays pump running information for ease of diagnostics so you can see what is going on with the pumps.
- Intelligent push button pump overload calibration prompts for incomplete calibration to guarantee that the pump current is set correctly protecting the pump from overload and dry running.
- Function switch setting for drainage, pressure boosting or transfer applications for easy adjustment to suit the application required.
- Level controls can be float switches or probes for versatile and customisable installation.
- Auto, manual switching so you can choose how it works. You can switch it to manual to empty the sump for servicing or repairs.
- Visible and audible alarms to better alert you if an issue arises.
- Adjustable time delay for audible alarm allows you to determine how long the alarm sounds for.
- Low voltage control circuit for safety the iCON control has a built in transformer so it only provides low voltage to the floats, pressure switches etc.
- RS485 communication interface (BMS, MODBUS) using a hardwired paired wire to a management system to communicate to the controller remotely.
- Pump accumulated run time display to monitor the run duration and assist in determining age of the pumps based on service.
- Last five pump faults if any logged into memory for better diagnostics if there has been a recurring problem with a particular pump.
- Slave controller included to be able to control the unit (everything except pump calibration and parameter setting) up to a max 1.2km from the main pump controller using STP – shielded twisted pair cable (not included).
- Control box contains MCB and DOL contactor to be able to turn the unit off to allow for servicing of pumps
- Provision for combinations of multiple device inputs and outputs for use with float switches, probes, pressure switches or external device alarms for versatility of application.
- In addition to the features listed above the dual pump controller (DPC) also has alternating pump starts and Automatic dry pump cycling (Anti Seize) and load sharing to extend the life of the pumps.

## DRAINAGE

- Applied for drainage by liquid level control through float switch or liquid probe
  - Flooding
  - Stormwater
- Moves excess water from a primary location elsewhere.
- In conjunction with the float switches or probes the iCON controller switches the pumps on and off as required to empty the sump.

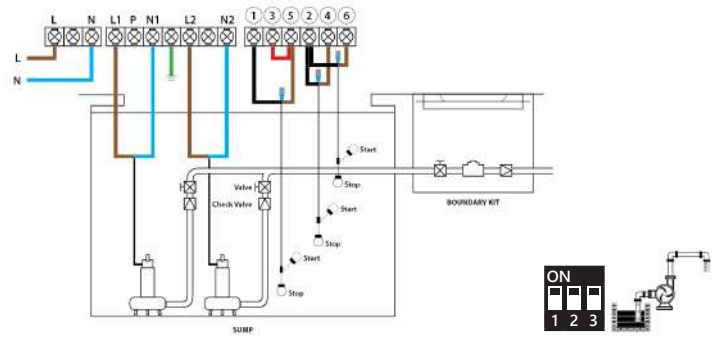

## DRAINAGE WITH AUTOMATIC PUMPS

- Applied for drainage (where pumps have their own float switches)
- Mainly used in instances where float cables can't be run through the conduit from the sump to the control panel.
- Generally because the builder has not laid a conduit large enough to fit: 2 x pump power leads and 3 x float cables.
- All that is required are the pump power leads and one float cable (overflow)

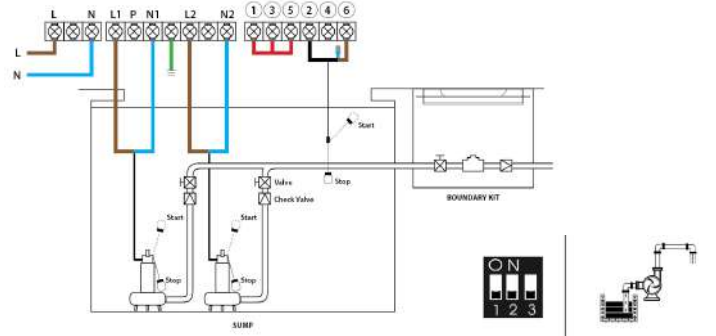

## TRANSFER

- Applied for water supply or drainage by liquid level control through float switch or liquid sensor
  - Dam to Water Tower
  - Tank to Tank
- Generally used when you need to move water from one location to another.
- The float switches are installed in both the source and destination of the water storages.
- iCON controller will only allow water to go to the destination if it is needed and the source has water to accommodate.

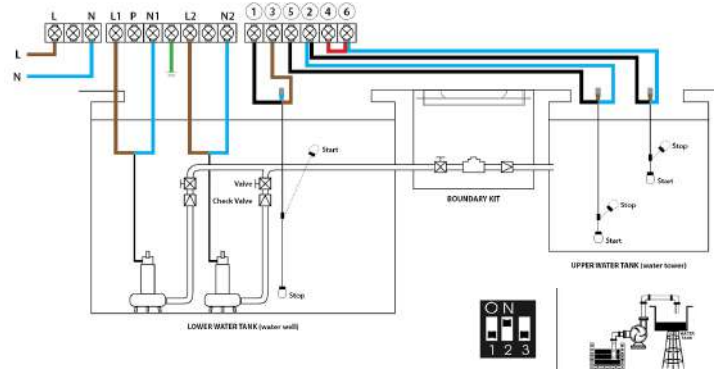

## HOT WATER CIRCULATION

- Applied for water supply by the thermal switch
  - High Rise Buildings
  - Hotels
  - Hospitals
  - Shopping Centres
  - Under Floor Heating
- The hot water line must have a return line installed for a circulator pump to work.
- If a thermostat is used you can set the temperature to kick in the circulator pumps to bring the cold water back to the boiler so that it is replaced by hot water.
- Used in situations where it is inconvenient or impractical to wait for hot water to come through the pipes.

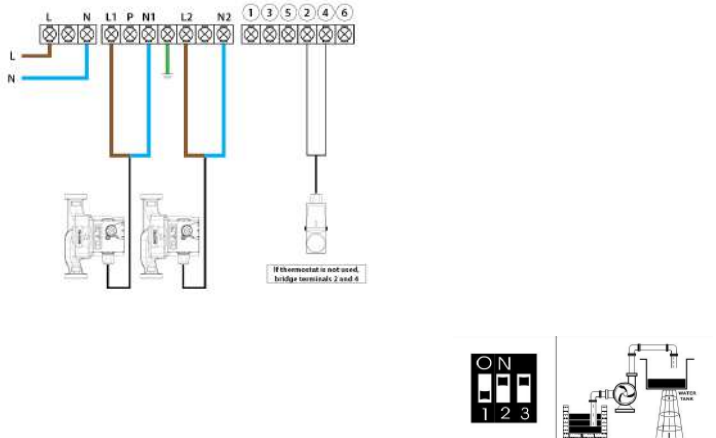

## BOOSTING

- Applied for water supply by pressure control through pressure switch and pressure tank
  - High Rise Buildings
  - Hotels
  - Hospitals
  - Shopping Centres
- Used in conjunction with a vertical multistage booster pump. The impellers boost the pressure of the water as it passes through to have enough pressure to service either a greater demand for water or a greater height than would otherwise be possible.
- Instead of floats, pressure switches are connected to the control panel to manage the pumps.

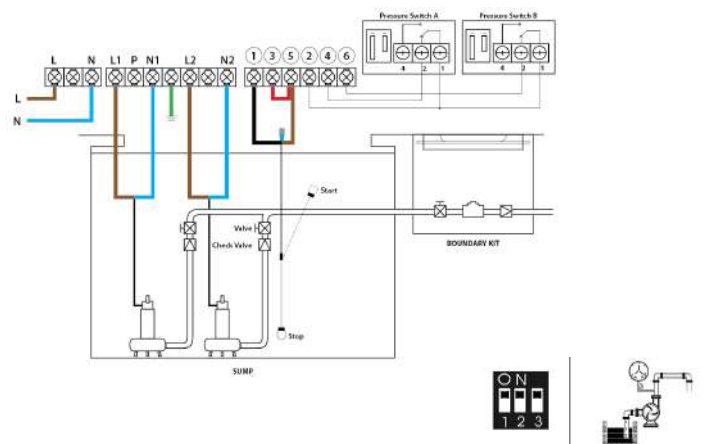

# ICON PROGRAMMING

SERIES CONTROLS

## PROGRAMME ICON CONTROLLER

- Check that the pumps have been installed correctly as per the instruction manual for the desired application.
- Check that the control panel is disconnected from the power supply and wait 2 minutes before opening the control panel.
- Adjust the function switches to suit the application as shown below

DRAINAGE	DRAINAGE with AUTOMATIC PUMPS	BOOSTING	TRANSFER	HOT WATER CIRCULATION

- Once dipswitches are set and floats, probes or pressure switches connected, turn internal MCB on, close the cover and connect the power supply.

- Calibrate the controller to the pumps.
- Fill the sump with enough water to be able to start the pumps.
- Press MODE and STORE keys together to unlock the controller and switch it to manual mode.
- Press A START key to run pump A and confirm that the pump and all pipe network is in a normal working state.
- Press the STORE button. The control panel will make a beep sound and a countdown starts from 5 to 0 with the LCD displaying:
- Press B START key to run pump B and confirm that the pump and all pipe network is in a normal working state.
- Press the STORE button. The control panel will make a beep sound and a countdown from 5 to 0 starts again.
- Press MODE to return to automatic

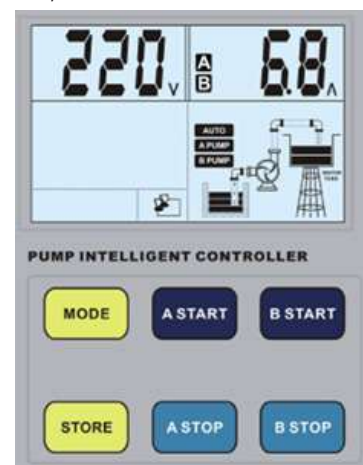

## HOW DOES IT PROTECT PUMPS?

- The controller itself will determine based on the pump calibration if anything is going on that requires attention.
- There will be an audible and visible alarm to alert you of a problem.
- Press A STOP to turn off the alarm for 5 minutes.
- Read what is on the display.

voltage displaying area

fault displaying area

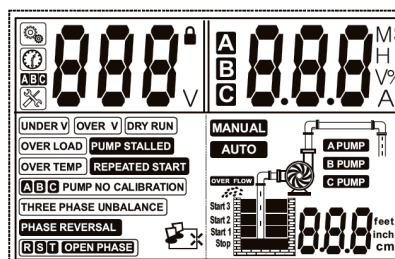

ampere displaying area

pump running status displaying area

## CHANGING PARAMETER SETTINGS

- Ensure panel is in manual and pumps are not running.
- Press MODE for 5 seconds until the controller beeps and the first parameter will be displayed.
- Press MODE to select to select the parameter code required.
- Press A START to increase the value and A STOP to decrease the value.
- Press MODE to select to select the next parameter code if required.
- When completed press MODE for 5 seconds until the controller beeps.

DPC1-22 PARAMETER	REV3 DEFAULT VALUE	RANGE	COMMENT
001	1	0-254	Communication address
002	4	0-4	Baud Rate 1200, 2400, 4800, 9600 bps
003	6 Seconds	0-60	Dry run protection trip response time
004	30 Minutes	1-254	Recovery time for dry run protection
005	5 Seconds	0-60	Overload protection trip response time
006	2 Minutes	0-6	Recovery time for over voltage protection
007	28.0 Amps	0.1-28.0	Running Amps A pump
008	28.0 Amps	0.1-28.0	Running Amps B pump
009	70 Percent	0-95	Trip ratio for dry run protection
010	125 Percent	0-170	Trip ratio for over load protection
011	195 Percent	0-195	Trip ratio for pump stalled protection
012	187 Volts	0-295	Under voltage protection trip voltage
013	253 Volts	0-295	Over voltage protection trip voltage
014	240 Hours	0-254	Pumps A and B run for 3 seconds to prevent seizing if pumps have not run during the cycle (drainage mode) (changeover time for pumps with floats, circulators)
015	5 Minutes	0-254	Time interval of sounding alarm
016	10 Seconds	0-254	Delay time of pump start

# ICON TROUBLESHOOTING

BIANCO  
SERIES CONTROLS

## PUMP NO CALIBRATION

- Pump no calibration is flashing
- Fill the sump with enough water to be able to start the pumps.
- Press MODE and STORE keys together to unlock the controller and switch it to manual mode.
- Press A START key to run pump A and confirm that the pump and all pipe network is in a normal working state.
- Press the STORE button. The control panel will make a beep sound and a countdown starts from 5 to 0.
- Press B START key to run pump B and confirm that the pump and all pipe network is in a normal working state.
- Press the STORE button. The control panel will make a beep sound and a countdown from 5 to 0 starts again.
- Press MODE to return to automatic

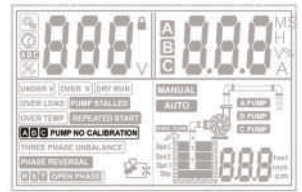

## OVERLOAD OR PUMP STALLED

- Overload or pump stalled is flashing.
- Pumps may not have been calibrated properly
- Remove previous calibration by:
- Switching it to manual mode (MODE & STORE)
- Press A STOP for 30 seconds until the panel beeps. Pump A no calibration should be displayed.
- Press B STOP for 30 seconds until the panel beeps. Pump B no calibration should be displayed.
- Calibrate the pumps one at a time by pressing START let the pump run and then STORE.
- Return to automatic by pressing MODE.

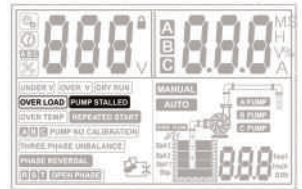

## OVERTEMP

- Overtemp is flashing.
- The red jumper leads between terminals 10 and 12, (and 9 and 11 for dual pumps) has been removed.
- Replace the leads – unless there is a set of pump microtherm wires to connect.

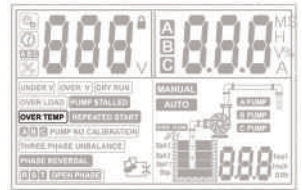
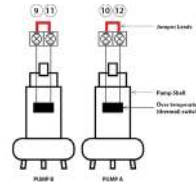

## DRY RUN

- Check that the float switches are not set too low, or if they are caught up inside the tank allowing air into the pumps.
- For surface mounted pumps, ensure that the pumps are primed and that any valving is open to allow flow into the pumps.

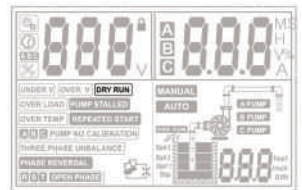

## REPEATED START

- This will flash if there are more than 5 starts per minute.
- Usually occurs on pressure systems. Check the tank pre-charge and bladder, pressure switch settings or defects.
- Pumps may be oversized or have flat performance curves.

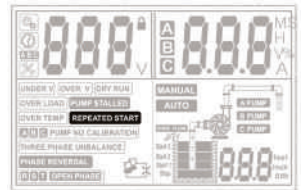

## UNDER V or OVER V

- Voltage is out of range.
- The pump will attempt to restart every 5 minutes until voltage is restored to normal.
- If it is unresolved, please discuss with the product manager

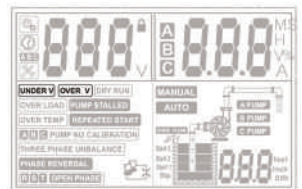

## PHASE REVERSAL

- 3 Phase only
- Incoming phase rotation has changed from when control panel was originally connected.
- When connecting pump rotation during commissioning, the pump connections must be changed, NOT the incoming power connection.
- If this has occurred, change the incoming connections and the pump connections together.

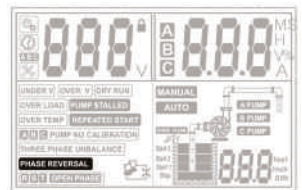

## NETWORK CONNECTION ERROR

- This is normal if the slave controller is not installed.
- If the slave controller has been installed and the error message appears, it means that there is no network connection or a connection error between the pump control box and the slave controller (or computer).

